



# Installation Guide

For 1CH Zigbee Switch Module SML-01Z-ES-16A

# Welcome!

This guide will walk you through the installation of the 1CH Zigbee Switch Module.

Start enjoying your smart home experience today!

## Content

In The Box .....	2
Appearance .....	3
Install 1CH Zigbee Switch Module .....	4
Set up 1CH Zigbee Switch Module .....	7

## In The Box

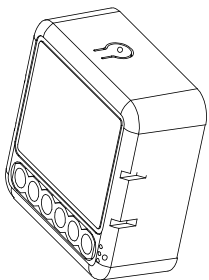

1CH Zigbee Switch Module(x1)

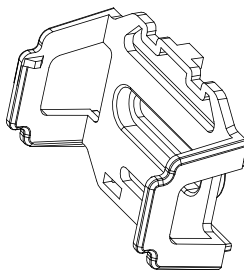

Mounting Clip(x1)

## Appearance

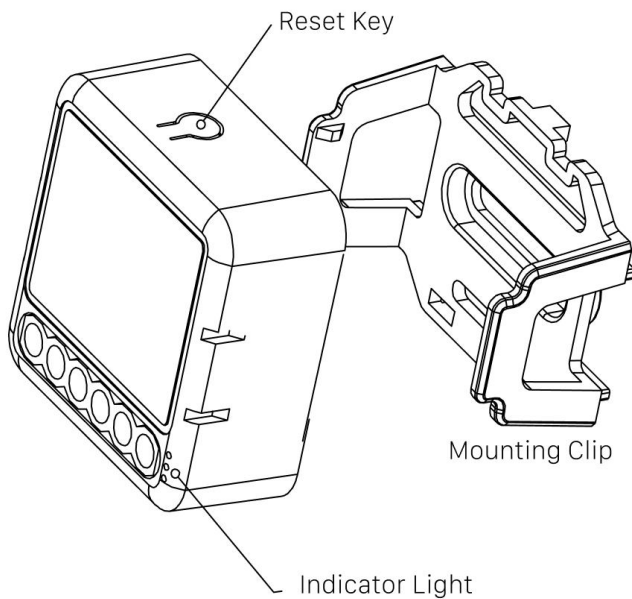

# Install 1CH Zigbee Switch Module



## WARNING: ELECTRIC SHOCK HAZARD

This product requires handling 100-240 volt wiring during installation. Please follow each instruction carefully. If you are not confident in handling electrical wiring, it is advisable to hire a qualified electrician. Ensure that all installation work adheres to relevant local and national electrical codes.

### 1 Turn Off the Power:

Always ensure the power is turned off before starting any work. Use an electrical tester to verify that no power is present.

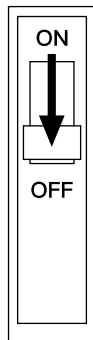

## 2 Connection Diagram:

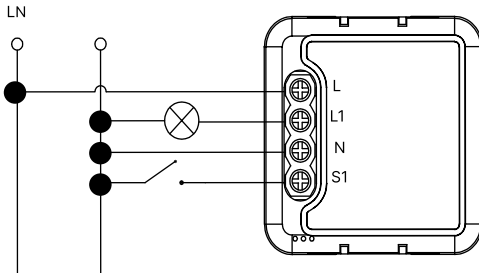

Single Control

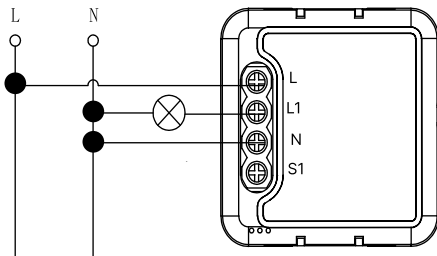

Without Switch

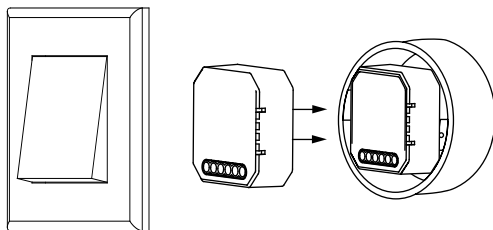

### 3 Turn On the Power:

After completing the work, ensure that all installations are secure and double-checked. Reconnect the power by turning on the fuse. Use an electrical tester to verify that the power is properly restored.

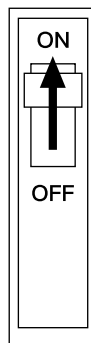

## ① Set up 1CH Zigbee Switch Module

To control the 1CH Zigbee Switch Module with a mobile device, install the Smart Life app. You can download the Smart Life app here.





## ② Add 1CH Zigbee Switch Module

1. Launch the Smart Life app and follow the displayed instructions.
2. Add the gateway to the app according to the Multi-function Gateway Installation Guide.
3. Once the Multi-function Gateway is successfully added, click on "+" and select "Add Device".

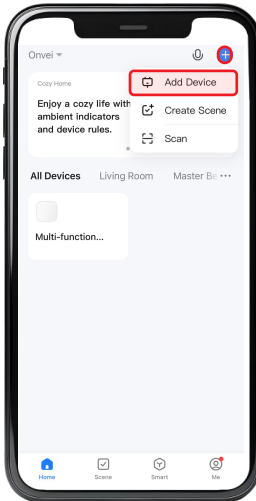

4. Navigate to the "Energy" category and choose "Switch Module Zigbee".

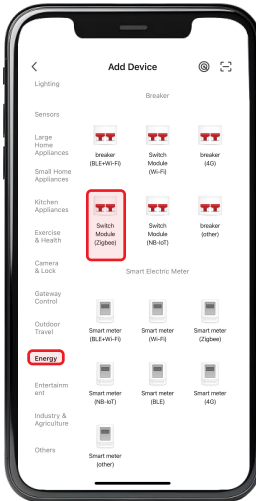

5. Select your gateway.

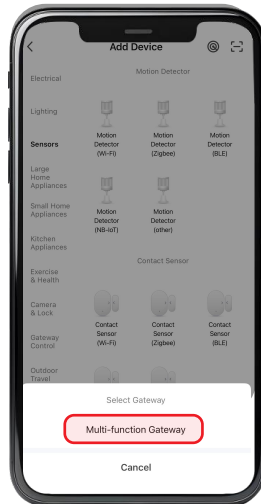

**Note:** The name of your gateway displayed in this section may differ from the name shown in this example image. It will display the name you have assigned to your device.

6. Select "Confirm the indicator is blinking" and click "Next".

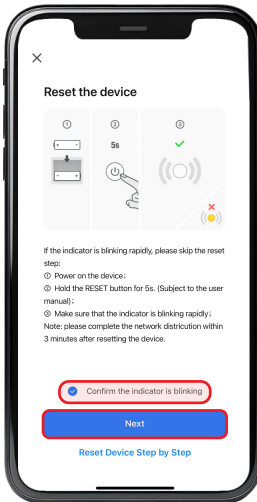

7. Connect the power to the device, The LED will flash rapidly. The device will automatically enter pairing mode.

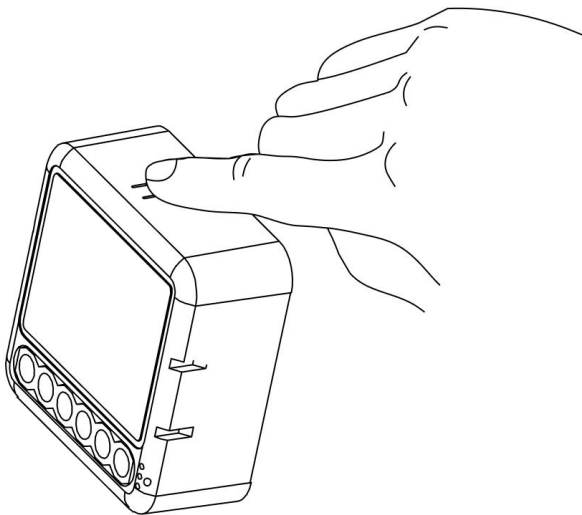

**Note:** Press and hold the button for 12 seconds to enter pairing mode. The blue LED will flash rapidly.

8. Wait for the app to detect and initialize the device.
9. After the device is detected and its name appears, click "Done".

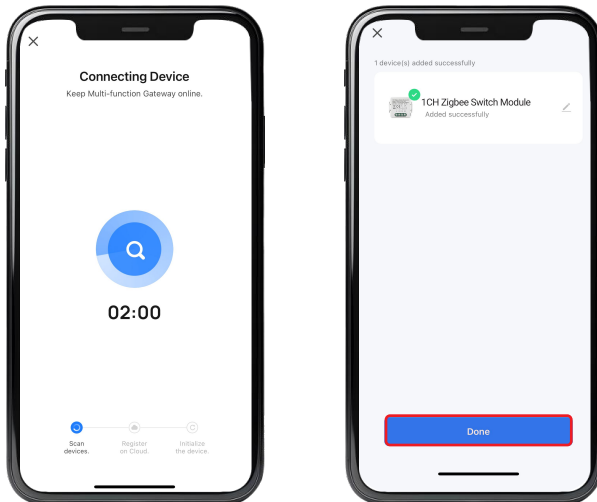

**Note:** Ensure you are within a suitable range of the device to establish a stable connection.

# Congratulations!

Your 1CH Zigbee Switch Module installation is complete.

Start Enjoying Your Smart Home Experience Today!

[onvei.com](https://onvei.com)