



Installation Guide

For Multi-function Gateway T3 Pro

Welcome!

This guide will walk you through the installation of the Multi-Function Gateway.

Start enjoying your smart home experience today!

Content

In The Box	2
Appearance	3
Light Status	4
Button Instruction	4
Install Multi-function Gateway	5
Set up Multi-function Gateway	6

In The Box

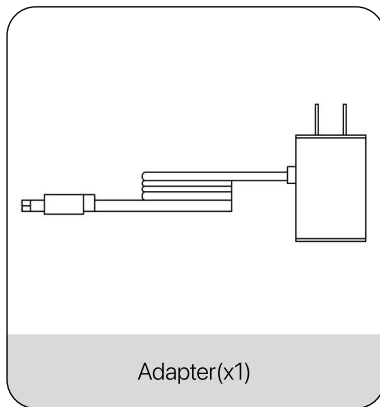
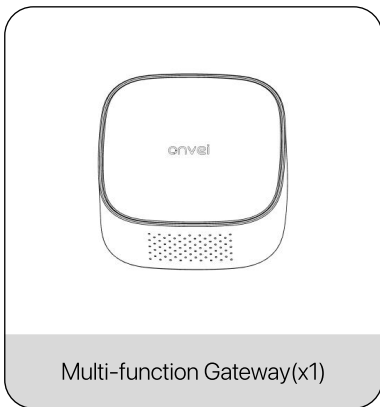

Appearance

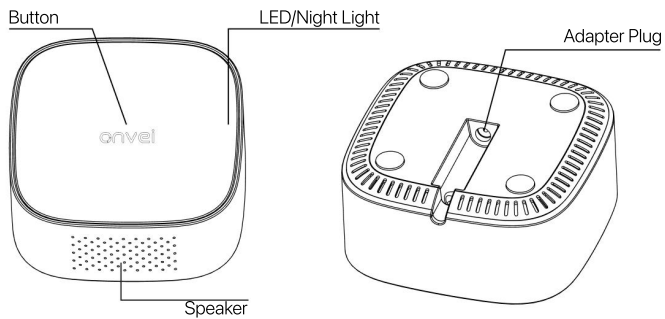

Light Status

Status	Color	Action
Power On	Blue	Normal On
Waiting for Connection	Blue	Flash once per 1.5 second
Night Light	Chromatic	Normal On
Alarm	Red	Flash, twice per second
Arm Away	Red	Constant ON
Network Disconnected		No Light
Fault		No Light

Button Instruction

Status	Operation
Arm mode On/Off	Double Click
Long press 12 Seconds to restore to factory setting	Long Press

Install Multi-function Gateway

1. Plug the provided power adapter into an electrical outlet.
2. Connect the other end of the power adapter to the gateway.
3. The gateway will turn on automatically.
4. The indicator light on the gateway will illuminate.

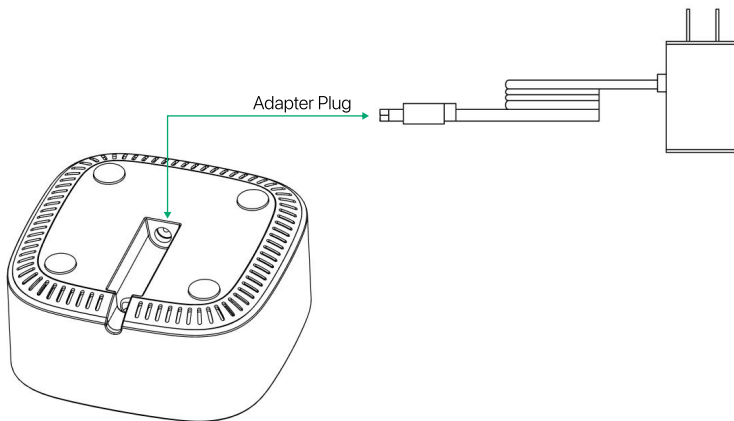

Note: Press and hold the button for 12 seconds to enter pairing mode. The blue LED will flash rapidly.

Set up Multi-function Gateway

1. Turn on Power.
2. To control the gateway with a mobile device, install the Smart Life app. You can download the Smart Life app here.



Add Multi-function Gateway

1. Open the app to create a new account and log in.
2. Press and hold the gateway's button for 12 seconds.
3. The gateway will enter configuration mode.
4. Click on "+" and then "Add Device", and it will automatically appear in the app.

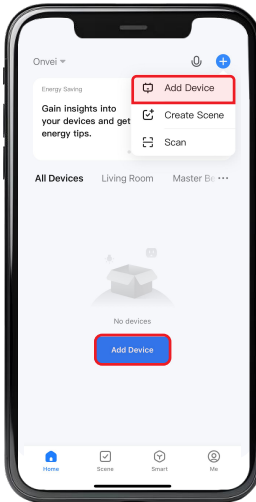

5. Connect the power to the device, The LED will flash rapidly. The device will automatically enter pairing mode

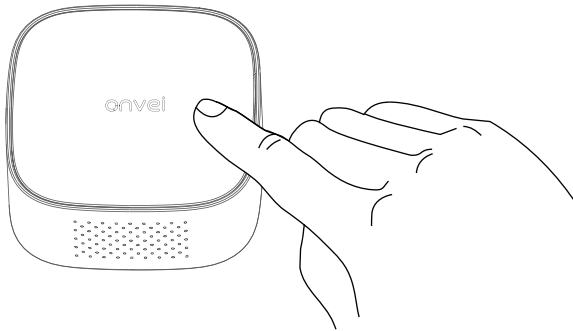

Note: Press and hold the button for 12 seconds to enter pairing mode. The blue LED will flash rapidly.

6. Select "Multi-Function Gateway"

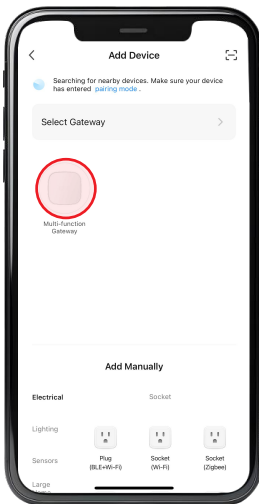

7. Choose your Wi-Fi network name and enter its password. Then, click on "Next".

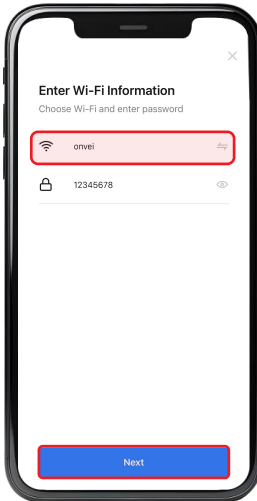

8. After confirming the installation information, click "Done" to connect the ZigBee devices.

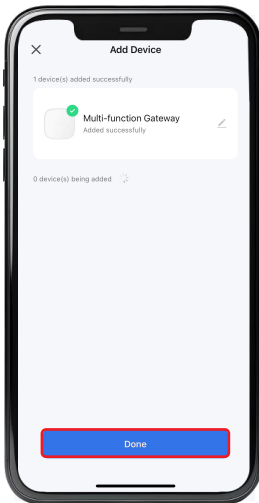

Add Zigbee Devices

1. Click "Sub Device" to connect the ZigBee devices.

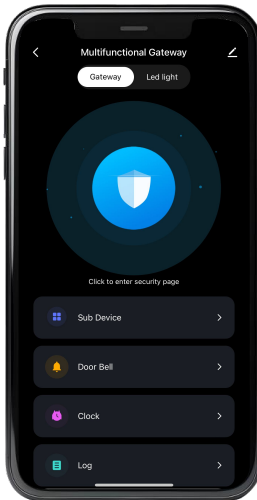

2. Then, select "ZigBee Device List".
3. Choose "Add Devices". Press and hold the pairing button on your ZigBee device until it enters pairing mode and appears on the list.

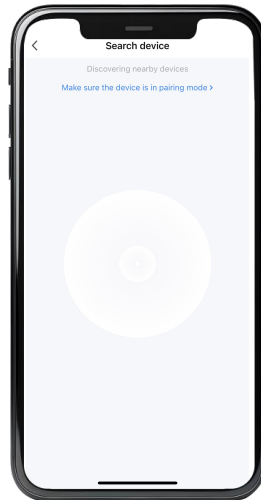
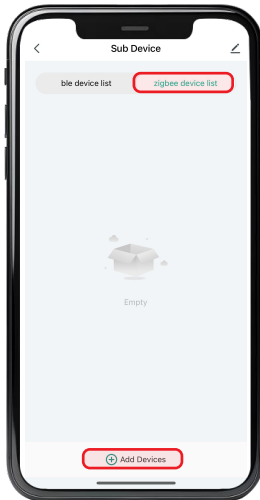

Congratulations!

Your Multi-Function Gateway installation is complete.

Start Enjoying Your Smart Home Experience Today!

onvei.com