



Installation Guide

For Smart Touch Dimmer Switch EDW-1ZBB-EU

Welcome!

This guide will walk you through the installation of the Smart Touch Dimmer Switch.

Start enjoying your smart home experience today!

Content

In The Box	2
Appearance	3
Install Smart Touch Dimmer Switch	4
Set up Smart Touch Dimmer Switch	9

In The Box

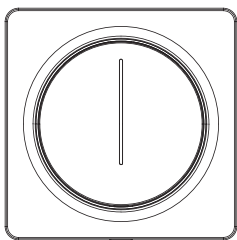

Smart Touch Dimmer Switch(x1)

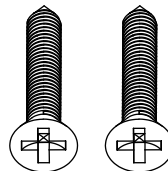

Screw(x2)

Appearance

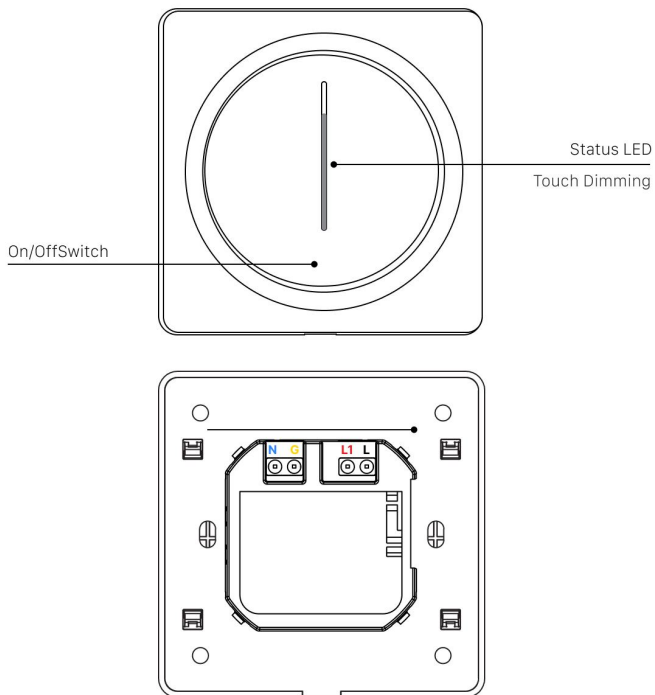

Install Smart Touch Dimmer Switch

Tools You'll Need

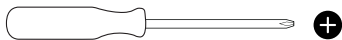

Screwdriver



Flat-head Screwdriver

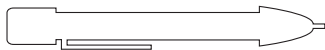

Voltage tester

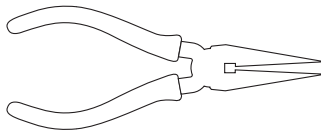

pliers

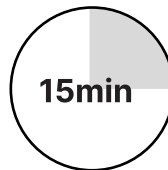

Approximately
15 minutes of your time
to install and setup
the Switch

Install Smart Touch Dimmer Switch



WARNING: ELECTRIC SHOCK HAZARD

This product requires handling 100-240 volt wiring during installation. Please follow each instruction carefully. If you are not confident in handling electrical wiring, it is advisable to hire a qualified electrician. Ensure that all installation work adheres to relevant local and national electrical codes.

1 Turn Off the Power:

Always ensure the power is turned off before starting any work. Use an electrical tester to verify that no power is present.



2 Connection Diagram:

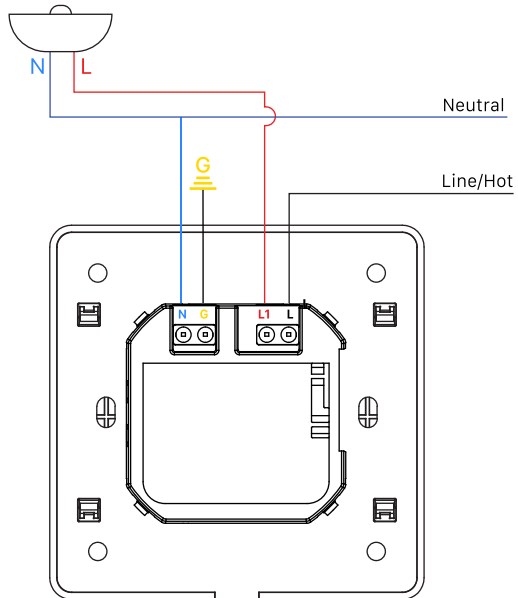

- 3 Remove The Panel:**
Remove the cover from the Dimmer.

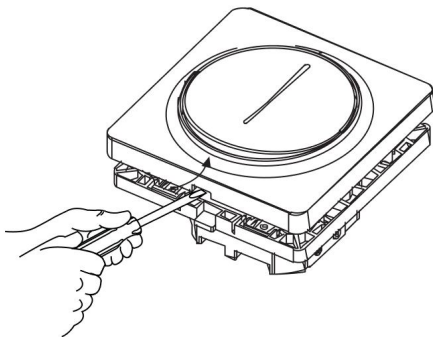

- 4 Mount the Dimmer:**
Secure the Dimmer using the provided screws.

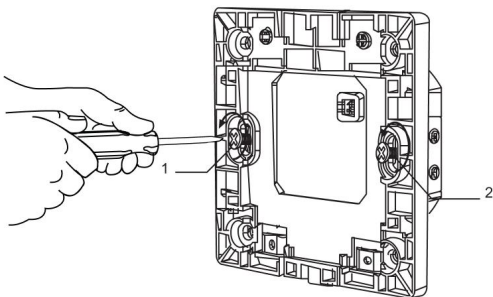

5 Cover Installation:

Align the cover correctly, then secure it in place.

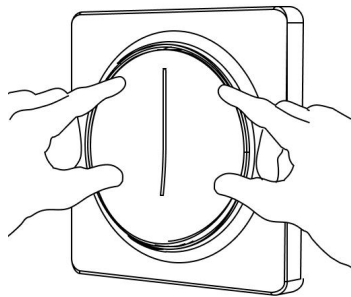

6 Turn On the Power:

After completing the work, ensure that all installations are secure and double-checked. Reconnect the power by turning on the fuse. Use an electrical tester to verify that the power is properly restored.

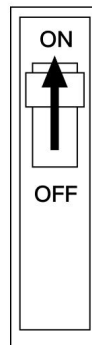

① Set up Smart Touch Dimmer Switch

To control the Smart Touch Dimmer Switch with a mobile device, install the Smart Life app. You can download the Smart Life app here.



② Add Smart Touch Dimmer Switch

1. Launch the Smart Life app and follow the displayed instructions.
2. Add the gateway to the app according to the Multi-function Gateway Installation Guide.
3. Once the Multi-function Gateway is successfully added, click on "+" and select "Add Device".

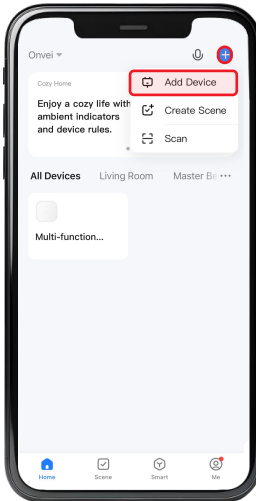

4. Navigate to the "Electrical" category and choose "Switch Zigbee".

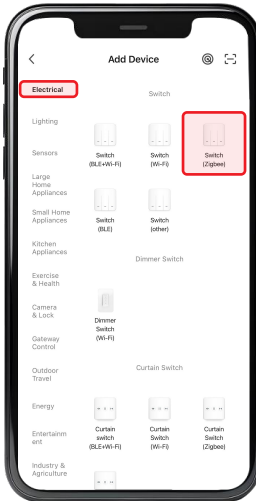

5. Select your gateway.

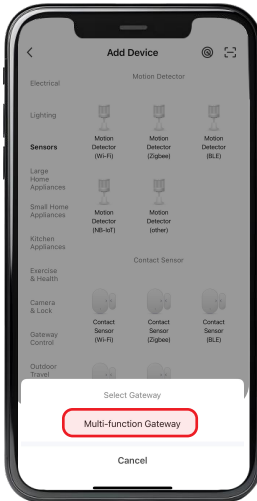

6. Press and hold the switch button for 10 seconds. When the indicator LED begins to flash, the switch will enter Pairing Mode.

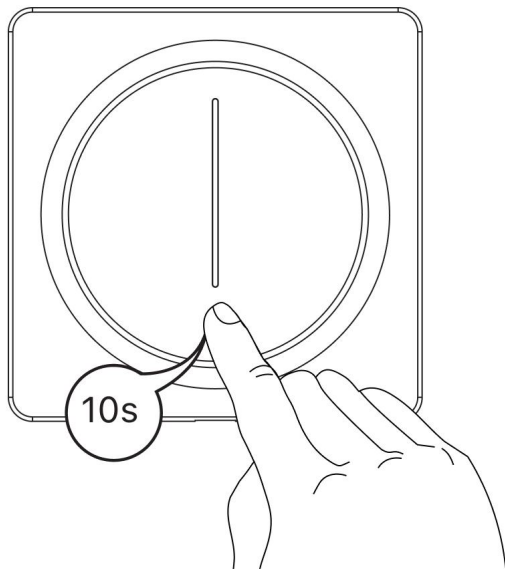

7. Select "Confirm the indicator is blinking" and click "Next".

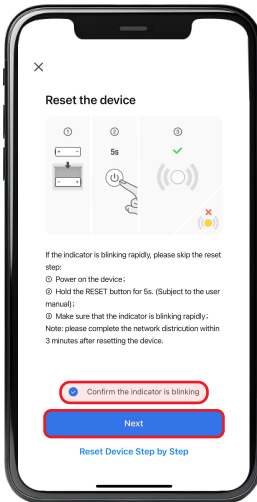

8. Wait for the app to detect and initialize the device.
9. After the device is detected and its name appears, click "Done".

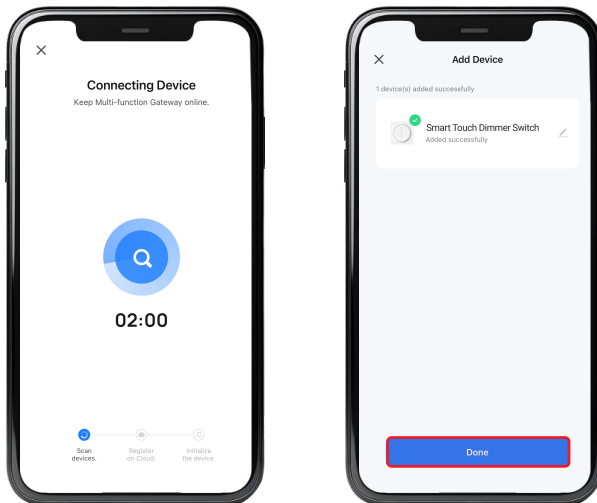

Note: Ensure you are within a suitable range of the device to establish a stable connection.

Congratulations!

Your Smart Touch Dimmer Switch installation is complete.

Start Enjoying Your Smart Home Experience Today!

onvei.com