

The logo for the brand 'onvei' is displayed in a lowercase, sans-serif font. The letters are dark grey or black, with a consistent weight and spacing. The background of the entire page is a solid teal color, featuring large, white, abstract shapes that resemble speech bubbles or rounded rectangles with curved corners, creating a modern and clean aesthetic.

onvei

Installation Guide

For Smart Wall Switch 1 Gang ESW-1ZBC-EU

Welcome!

This guide will walk you through the installation of the Smart Wall Switch 1 Gang.

Start enjoying your smart home experience today!

Content

In The Box	2
Appearance	3
Install Smart Wall Switch 1 Gang	4
Set up Smart Wall Switch 1 Gang	10

In The Box

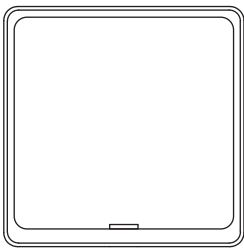

Smart Wall Switch 1 Gang(x1)

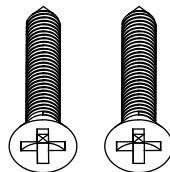

Screw(x2)

Appearance

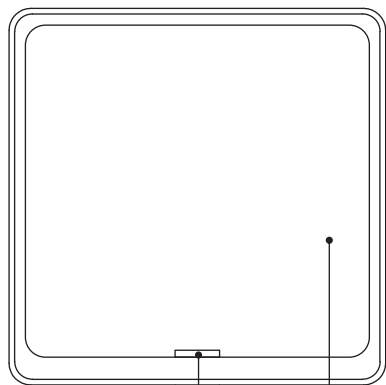

Indicator LED

Button/Reset

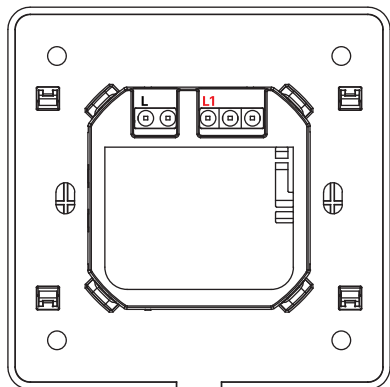

Install Smart Wall Switch 1 Gang

Tools You'll Need



Screwdriver



Flat-head Screwdriver

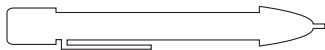

Voltage tester

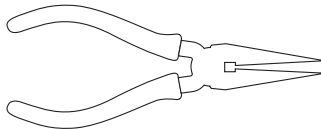

Pliers



Approximately
15 minutes of your time
to install and setup
the Switch

Install Smart Wall Switch 1 Gang



WARNING: ELECTRIC SHOCK HAZARD

This product requires handling 100-240 volt wiring during installation. Please follow each instruction carefully. If you are not confident in handling electrical wiring, it is advisable to hire a qualified electrician. Ensure that all installation work adheres to relevant local and national electrical codes.

1 Turn Off the Power:

Always ensure the power is turned off before starting any work. Use an electrical tester to verify that no power is present.

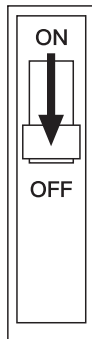

2 Connection Diagram:

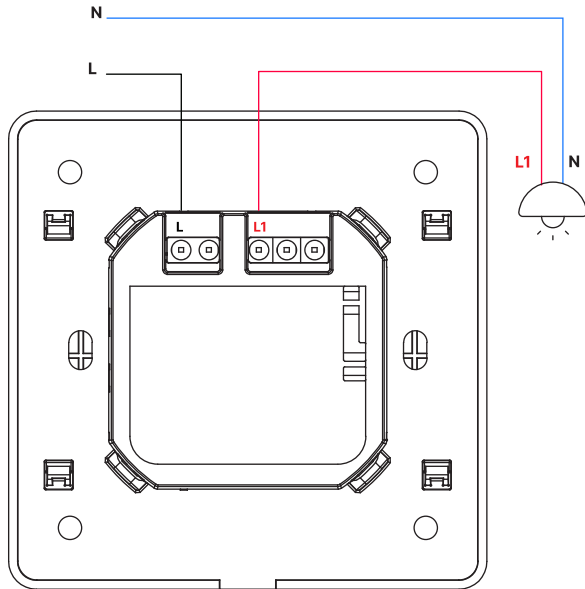

3 Remove The Panel:

Remove the cover from the switch panel.

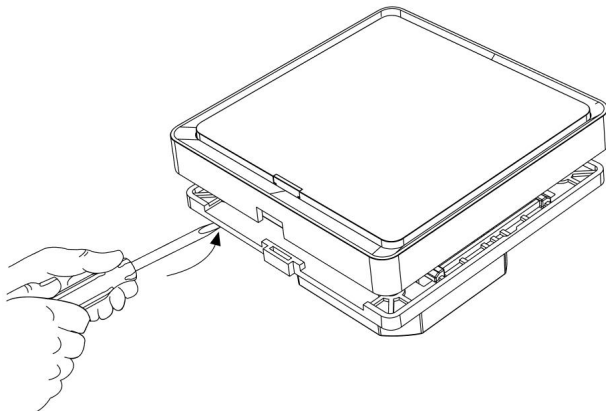

4 Mount the Switch:

Secure the switch using the provided screws.

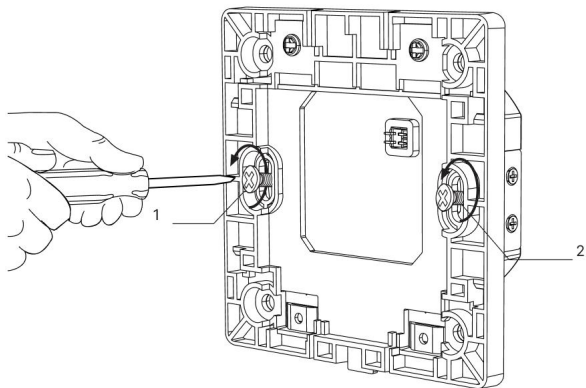

5 Cover Installation:

Align the cover correctly, then secure it in place.

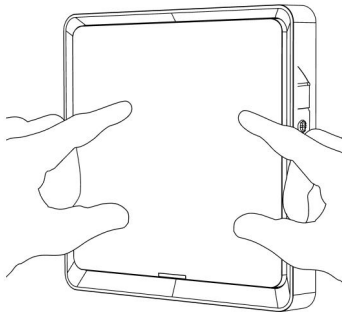

6 Turn On the Power:

After completing the work, ensure that all installations are secure and double-checked. Reconnect the power by turning on the fuse. Use an electrical tester to verify that the power is properly restored.



① Set up Smart Wall Switch 1 Gang

To control the Smart Wall Switch 1 Gang with a mobile device, install the Smart Life app. You can download the Smart Life app here.



② Add Smart Wall Switch 1 Gang

1. Launch the Smart Life app and follow the displayed instructions.
2. Add the gateway to the app according to the Multi-function Gateway Installation Guide.
3. Once the Multi-function Gateway is successfully added, click on "+" and select "Add Device".

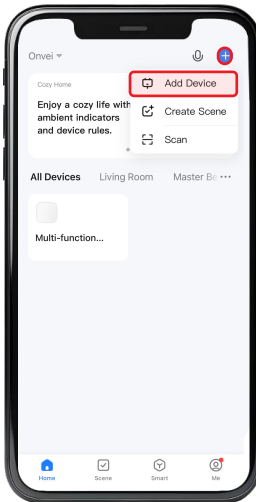

4. Navigate to the "Electrical" category and choose "Switch Zigbee".

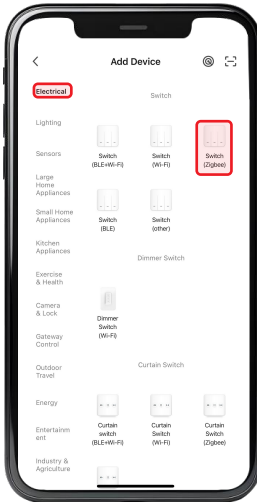

5. Select your gateway.

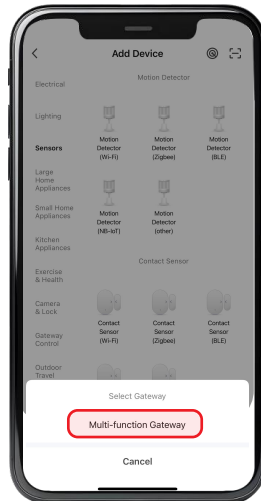

Note: The name of your gateway displayed in this section may differ from the name shown in this example image. It will display the name you have assigned to your device.

6. Select "Confirm the indicator is blinking" and click "Next".

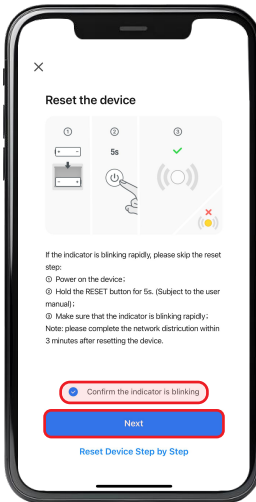

7. Press and hold the switch button for 10 seconds. When the indicator LED begins to flash, the switch will enter Pairing Mode.

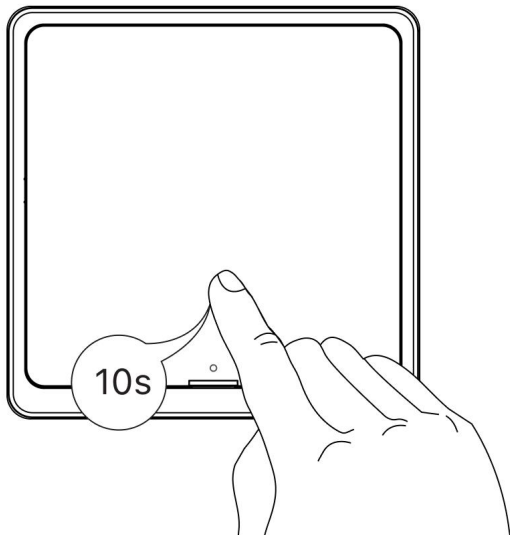

8. Wait for the app to detect and initialize the device.
9. After the device is detected and its name appears, click "Done".

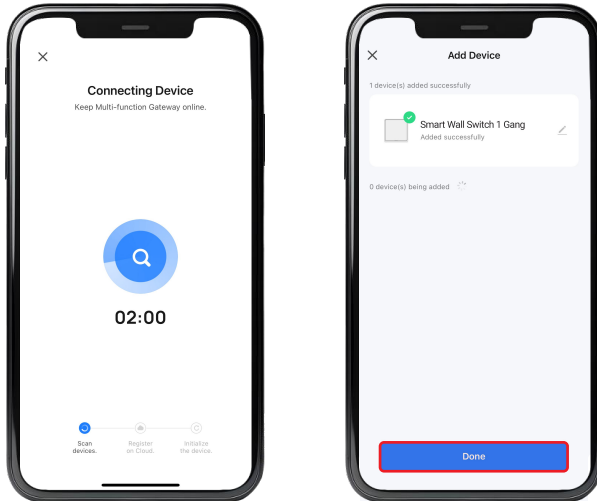

Note: Ensure you are within a suitable range of the device to establish a stable connection.

Congratulations!

Your Smart Wall Switch 1 Gang installation is complete.

Start Enjoying Your Smart Home Experience Today!

onvei.com